

DRIVE SPIKE

Cone Neck OI-758307 (Galvanized)

Spacing Blocks (Typical Application)

Fasten blocks to ties with 10" nails. Jack ties and spacing blocks tight before applying tie spacing bar.

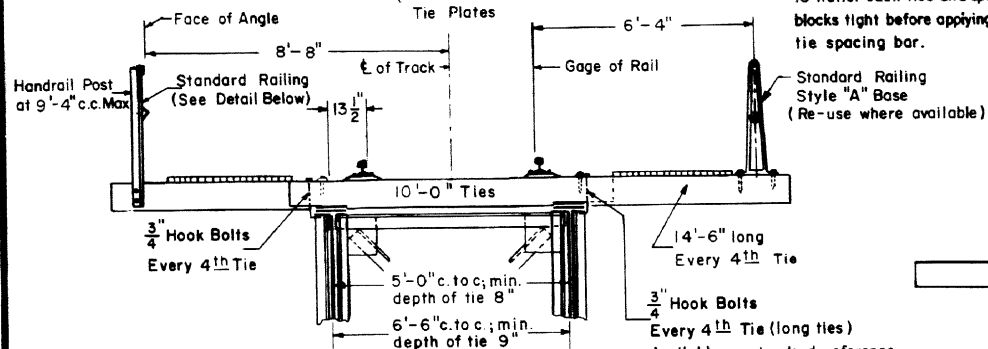

Inner Bridge Guard Rails to be installed as per M.W.-4 Paragraph 145

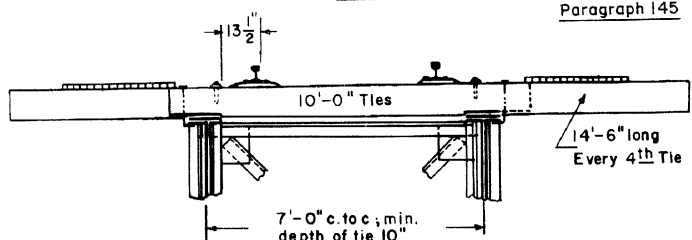

SINGLE TRACK DECK PLATE GIRDER BRIDGES

Support grating with long ties, every 4th Tie, as shown or on timber (sleepers) from flange to flange.

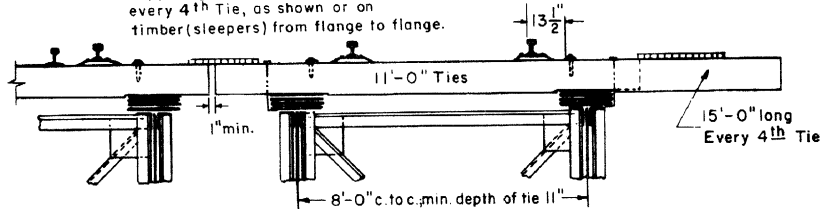

DOUBLE TRACK DECK PLATE GIRDER BRIDGES

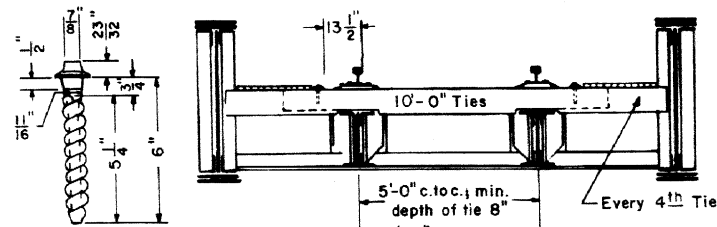

THROUGH PLATE GIRDER BRIDGES

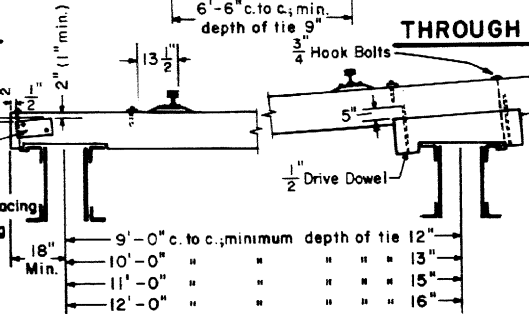

DECK TRUSS BRIDGES

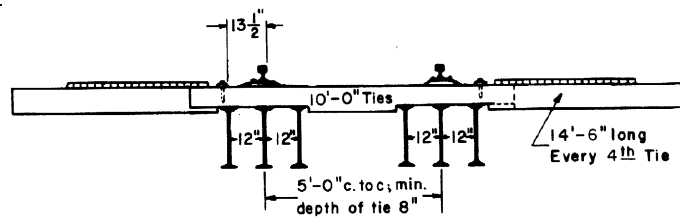
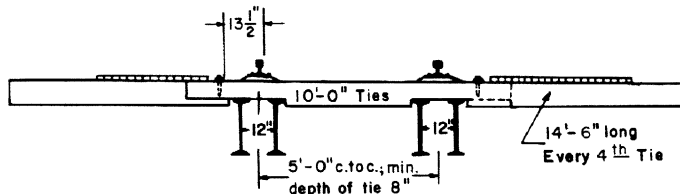

I BEAM BRIDGES

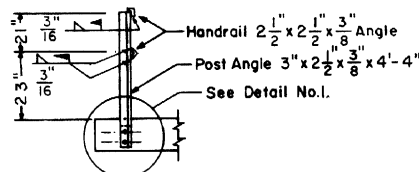

HANDRAIL DETAIL STANDARD ANGLE POST

(A. S. T. M. Specs. A-588)

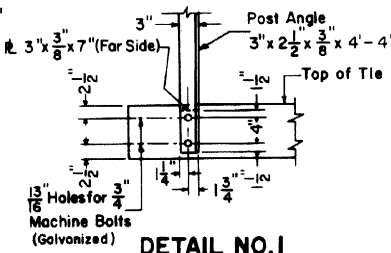

DETAIL NO. 1

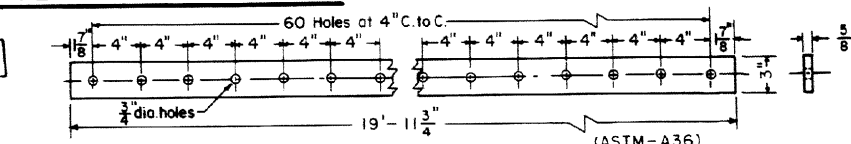
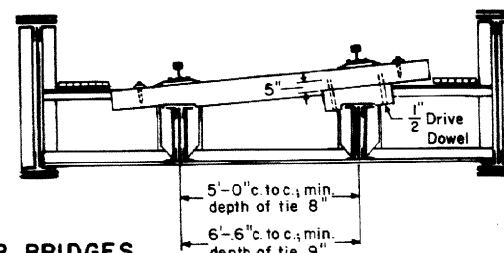

TIE SPACING BAR

Spacing blocks shown with W=5" will provide 14" spacing with 9" wide ties and should be shown on requisition as 5" spacing block.

In order to space ties and miss cover plates on deck girder bridges or to fit ties on stringers between floor beams, it may be necessary to provide spacing blocks less than 5" wide. Spacing blocks may be ordered with "W" dimension varying from 2" to 5" by 1" increments. The "W" dimension will provide the name for the spacing block and should be shown accordingly on requisition. For Example 4" block-W=4"; 5" block-W=5".

Blocks are to be used on all bridge structures (open deck).

SPACING BLOCKS

NOTES

- All bridge ties shall be 9" wide on top and spaced on 14" center to center.
- The depth of tie (undapped) at middle of span shall be as shown. After dapping the, minimum depth remaining over cover plates shall be equal to specified depth of tie less 1/8". Center portion of tie should not exceed dap by more than 1/2".
- Ties shall be ordered in inch depth. Requisitions must be accompanied by detailed plans for framing timbers.
- On curves, the super-elevation of track shall be obtained by the use of beveled ties where possible. Additional elevation shall be obtained by the use of raising blocks under ties, fastened with 1/2 inch drive dowels extending not less than 5" into tie.
- Stringers on 5'-0" centers will require use of Special Tie Anchors. Use Anchor Clip No. B-6555 manufactured by The Rails Co.
- Steel grating shall be galvanized, with carrying bars a minimum of 1 1/4" x 3/8" at 1 3/8" o.c. and 5/16" square cross bars 4" o.c., welded construction, with all ends banded. Use 2'-0" x 20'-0" panels where possible. Footwalks to be used only where railroad operations or state require.
- Drive spikes, track spikes and grating spikes shall be driven into prebored holes.
- Planking shall be used only where required to protect public highway.

CONRAIL 79401-A

STANDARD

TIMBER DECK WITH STEEL GRATING FOOTWALKS STEEL BRIDGES AND TURNABLES

SEPTEMBER, 1982

J. R. Clark
Chief Engineer - Maintenance of Way

A. G. Gordon
Chief Engineering Officer